



RC4Magic Series 3
DMXpix



Wireless Pixel Driver
Quick Start Guide

v1.2

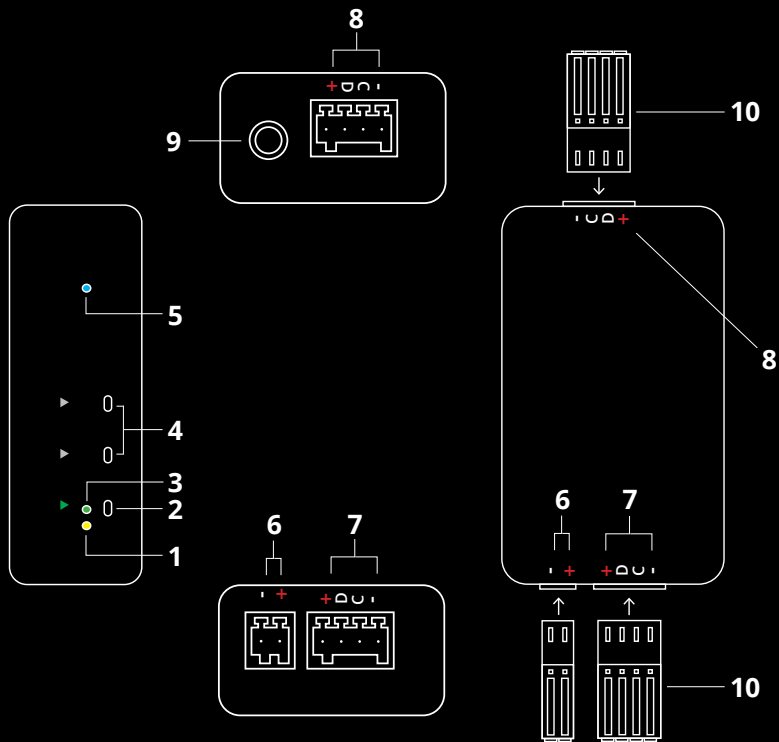

RC4Magic DMXpix

1. DMX Data Indicator
2. Function and COP ³ Indicator
3. Function Button
4. SetA, SetB Buttons
5. RF Connect Indicator for Transmitter Linking
6. DC Power Input, + and - as indicated
7. Pixel Control Port A ¹
8. Pixel Control Port B ¹
9. DMX/RDM Data In/Out
10. Removable Phoenix Connectors for Power and Pixels ²

¹ Pixel Control Ports provide 4 connections:

- + Positive power to pixels
- D Data line for pixel control
- C Clock line for pixel control (not used with 3-wire pixel products)
- Negative (ground) power to pixels

For pixel loads drawing more than 6A, pixel power should connect DIRECTLY to the power supply or battery, NOT through the DMXpix. A common ground (-) is always required between the DMXpix and the pixels.

² One set of connectors is provided with each new DMXpix.

Additional sets of connectors available separately from RC4 Wireless.

³ COP means "Computer Operating Properly." This indicator always shows a blink pattern, proving that internal firmware is running. Different patterns indicate various modes and advanced settings.

DMXpix Quick Start Guide

Your RC4Magic DMXpix has a wide variety of patented features that reduce the number of DMX control channels needed to create beautiful looks **with up to 1000 pixels**. Parameter settings, as a collection, are called an **RC4 Custom Pixel Profile™** or CPP. CPPs are ideal for pattern-based (rather than video-based) applications of pixel tape, pixel panels, festoon strings, and other pixel products. The small size and light weight of the DMXpix make it perfect for costumes and small props, even hats and wigs.

Right out of the box, the DMXpix operates like most DMX-controlled pixel drivers. Default CPP settings immediately control up to 170 WS2812* three-color pixels with one 512-channel DMX universe, starting on the first channel. Unlike other drivers, you can connect more than 170 pixels to your DMXpix and the universe of data will repeat, over and over, up to 500 channels per output driver. CPP parameters let you adjust how this process unfolds.

This guide helps you discover how to make big looks with fewer resources and in less time, using any of the most popular pixel types, including 3-wire and 4-wire data formats, 3-color and 4-color pixels, and more.

* WS2812 is one of several types of pixel you can control with your DMXpix, and is the most common and widely used type. There are many products on the market that are compatible. Most 3-wire pixel products use the same driver settings.

Registering Your Product

Registering your DMXpix is quick and easy. After registration, you'll be notified of new firmware updates, and warranty claims can be resolved more quickly.

Please complete your registration at:
www.rc4wireless.com/support/register/

DMXpix System Components

To use your DMXpix wireless dimmer you will need:

- A DMX lighting console.
- An RC4Magic Series 2 or Series 3 DMXio Transceiver.
- A battery or DC power supply for the DMXpix and pixel products you will be operating with it.
- A set of Phoenix connectors (one set is included with the DMXpix)
- A small tool, like a bent paperclip, to press the recessed buttons on the DMXpix, and to press the wire-release buttons on the connectors for power and pixels.
- A pixel product, like WS2812 (the default type) pixel tape.

RC4Magic Private IDentities™

RC4 Private IDentities™, unique to RC4Magic wireless DMX systems, keep your data private and safe on a Virtual Private Network (VPN).

Each Private ID transports a separate DMX universe. Multiple systems can operate at the same time for multiple wireless universes in the same space.

Each new RC4Magic customer and project is assigned a unique set of Private ID codes — nobody else has your IDs. They are marked on each device. Please note your private IDs below. When you add devices to your system, you must verify your IDs at time of purchase:

ID0 _____ ID1 _____ ID2 _____

ID3, code 999, is the RC4 Public ID. It is identical in all RC4Magic Series 2 and Series 3 devices ever made. Always use one of your private IDs when possible.

Your Private ID0, the factory default, is ideal for most users.

Confirming and Setting an RC4 System ID

All RC4Magic devices being used together must be set to the same RC4 System ID.





On power-up, the currently selected System ID is indicated with a blink pattern on the DMX Data and COP indicators. The four different patterns are noted below.

The factory default ID0 is indicated with a few rapid blinks of the yellow DMX Data LED on power-up. A factory reset will restore this ID setting.

An ID can be selected by holding one button or a pair of buttons on power-up. The blink pattern for the newly selected ID will appear on the indicators. You can also confirm the currently selected ID at any time by cycling power and watching the blink pattern that appears at start-up.

To select ID0, hold the SetA button, apply power, and release the button when the blink pattern appears. To select ID1, hold the SetB button and apply power. To select ID3 (the public, not private, ID), hold both SetA and SetB and apply power. **NOTE: On 3-button devices, ID2 can only be selected with RC4 Commander software.**

All RC4Magic Series 3 devices indicate IDs in the same way, making it easy to quickly confirm that all devices in your system are set correctly to work together.

-  **ID0 (default)**, yellow blink. Hold SetA on power-up to select ID0.
-  **ID1**, green blink. Hold SetB on power-up to select ID1.
-  **ID2**, yellow and green blink together. *Cannot be selected manually.*
-  **ID3 (public)**, yellow and green alternate. Hold SetA & SetB on power-up to select ID3. *Note: ID3 is public and is less secure than Private IDs.*

Phoenix Connectors for Power and Pixels

Power and pixel connections are made with Phoenix COMBICON FK-MC Series removable connectors. One set of mating connectors is included with the DMXpix. Additional connectors can be purchased from RC4 Wireless. * Connecting wires is easy:

- Wire must be in the size range of 0.5mm² to 0.75mm² (20 - 18 AWG).
- Strip 8mm (5/16 inch) of insulation from the end of each wire.
- Use a small screwdriver to hold down the orange spring-release button above the wire-entry hole.
- While holding the button, fully insert the bare wire end into the hole.
- With the wire fully inserted, release the orange button.
- Firmly but gently pull back on the wire to confirm a good grip on the wire.

NOTE: It is helpful to use a small vice, spring-loaded clamp, or pliers to hold the connector upright while inserting wires.

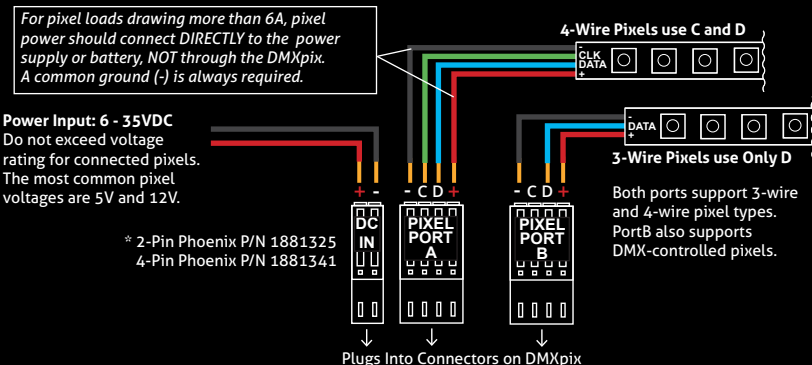

Connecting with an RC4Magic DMXio Transceiver

All RC4Magic devices **configured on the same RC4 Private Identity™** will automatically connect and form a VPN (Virtual Private Network). Confirm that each device in your system is labeled with the same RC4 Private Identity™ codes, and that each device indicates the same System ID selection on power up (see page 7). The default is ID0, which is fine for most users.

When first powered up, or after a transmitter has gone off and then come back on line, **receivers can take up to 10 seconds to join the VPN**. This is normal, and it is usually much less than 10 seconds.

A DMXio transceiver in Auto Mode (the default setting) will automatically detect wired DMX data from your console and establish itself as the master transmitter.

RC4Magic devices from a different system will not work with your RC4 Private IDs. This is the key to RC4Magic data security and superior performance for all users.

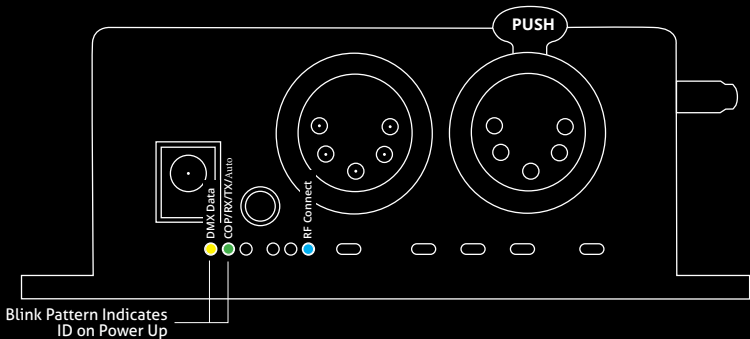

RC4Magic Indicator LEDs After Power-Up

The **COP** indicator blinks with different patterns to indicate various device modes. The **DMX Data** LED indicates that DMX data is present, either from a connected DMX controller, or from the VPN wireless link. If the yellow indicator is not active, no DMX data is present.

DMX Data: Yellow blinks with data packets and may appear irregular:

On DMXio transceivers operating in transmitter mode (see page 8), the RF Connect LED blinks slowly to indicate that a wireless VPN has been formed and the DMXio is the master transmitter:

DMXio, Transmit Mode COP Pattern: Green long blinks indicate transmitter mode:
RF Connect:

RC4Magic Series 3 (2.4GHz)

If your DMX2dim has a **purple** and black label, it is part of an **RC4Magic Series 3 system operating in the 2.4GHz band**. The RF Connect indicator remains on (not blinking) while the DMX2dim is searching for your VPN. It blinks quickly and continuously while your DMX2dim is connected to your wireless VPN.

DMX2dim RF Connect, Searching:
Connected:

RC4Magic-900 (900MHz)

If your DMX2dim has a **blue** and black label, it is part of an **RC4Magic-900 system operating in the 900MHz band**. The RF Connect indicator is always blinking, and indicates only that the RF system is functional, not whether or not it has joined a VPN. Use the DMX Data indicator to confirm that streaming DMX is present.

DMX Data Received Wirelessly:

RC4 Custom Pixel Profiles™

The DMXpix with patented RC4 Custom Pixel Profiles™ (CPP) provides a simple but powerful means of creating and controlling up to 1000 pixels. RC4 CPP vastly reduces the number of channels needed, while supporting a level of designer creativity not possible with other channel-saving techniques. Unlike drivers that provide preset or canned effects, CPP still allows you to create your own patterns in real time from your DMX console.

Instead of having your console handle the replication of patterns across a large number of pixels, which consumes at least 3 channels (and sometimes more) per pixel, that duty is moved to the pixel driver and handled by RC4 Custom Pixel Profiles™.

Keyframes



You decide how many DMX channels will be used for creating your pattern by setting the **Keyframe Length**. A Keyframe Length of 170 pixels (the default) will map 510 DMX channels directly to pixels, as is done with most DMX-controlled drivers.

Setting a shorter Keyframe Length reduces the number of channels needed to display patterns nearly identical to what an expensive console generates using multiple universes and huge numbers of DMX channels.

The keyframe length can be anything from 1 to 170 pixels long. A particularly powerful and channel-conservative Keyframe Length is 60 pixels*, which utilizes just 180 DMX channels, approximately 35% of one DMX universe.

Replication (Duplication, Mirroring, etc.)



The DMXpix and CPP driver replicates the keyframe down the entire length of connected pixels, up to 500 for each of two pixel driver ports. A variety of **Replication Methods** are available to choose from, and more will be added with future firmware updates.

Replication works even with a Keyframe Length of 170, allowing one port to control 500 pixels with only the data for the first 170. Two ports provide a total of 1000 3-color pixels controlled from a single DMXpix.

Grouping



Another way to reduce DMX channels while controlling more pixels is **Grouping**. In this case, the DMXpix with CPP controls multiple physical pixels with one console pixel. A Group Length setting of 3 will cause each console pixel to control three physical pixels in a row. This is the equivalent of nine (or more) DMX channels if done from the console. Grouping effectively widens the visual pattern or effect without consuming more DMX channels.

The combination of **Keyframe Length**, **Group Length**, and **Replication Method**, applied to patterns generated live by the lighting console, ensures maximum creative flexibility while substantially reducing the number of DMX channels needed. *CPP parameters are described in detail on pages 14 - 17.*

* A Keyframe Length of 60 is evenly divisible by 2, 3, 4, 5, 6, 10, 12, 15, 20, and 30, making it easy to create the appearance of varying pattern lengths without the need to actually change CPP settings in the DMXpix. Of course, there are numerous lengths with interesting benefits and advantages.

RC4 OneTouch™ for Setting Parameters with DMX Channel Levels

NOTE: To use RC4 OneTouch™, the DMXpix must be paired with an RC4 Magic DMXio transmitter, and live DMX channel data must be streaming.

RC4 OneTouch™ uses four DMX channel levels to assign values to DMXpix parameters. Channel levels are captured and saved with the press of a single button for each driver port using the SetA and SetB buttons.

While you are using OneTouch™, only DMX channels that are setting parameters should be at levels above zero. All other channels should be off. *NOTE: Channels being used in your DMX system for house-lights and moving light parameters (like pan and tilt) must also be at true zero.*

When a OneTouch™ button is pressed, the driver sets the first non-zero channel as the DMX Start Channel. In addition, the level of that channel selects one of four popular pixel types. The three channels immediately following the DMX Start Channel are used to set Keyframe Length, Group Length, and Replication Method.

Settings are remembered even when power is cycled. After parameters are set, return to using your DMX console as you normally do, controlling DMXpix pixels and everything else in your lighting system.

Using RC4 OneTouch™ is easy:

1. Set channel levels to reflect desired settings for a driver port.
2. Press the Set button for the port.
3. Repeat for other ports, and other devices in your system.
4. Proceed with using your DMX console as you normally do.

RC4 OneTouch™ Implementation in DMXpix

In the implementation chart below, channel S is the DMX Start Channel, range 1 to 512. The level of channel S and the next three channels set RC4 Custom Pixel Profile™ parameters. *Parameters are described in detail on pages 14 - 17.*

Before pressing a Set button, the start (S) channel must be at the correct level for the pixel type being used. If the level of any subsequent parameter channel is at zero, the previous setting for that parameter is retained. This makes it easy to change only the start channel and pixel type.

DMX Start Channel for Pixel Control:	S (any chan from 1 to 512)
Keyframe Length in Pixels:	S + 1
Group Length in Pixels:	S + 2
Pattern Replication Method:	S + 3

OneTouch™ channel levels only matter at the moment a Set button is pressed.

Example:

DMX Start Channel 74 (first non-zero ch is 74)

WS2812 Pixel Type (start ch at level 77, which is 30%)

60-pixel Keyframe Length (first ch above Start, ch 75, set to level of 60)

Pixels controlled in Groups of 3 (ch76 set to level of 3)

Increment/Decrement Replication Method (ch 77 at 55, which is 22%)

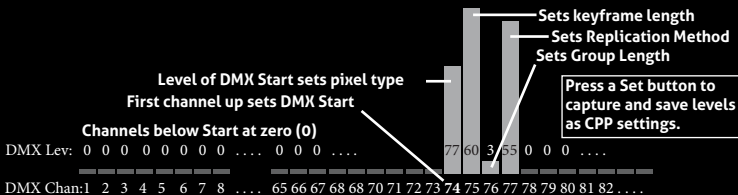

Set DMX Start Channel and Pixel Type for Each Port

To use RC4 OneTouch™, the DMXpix must be paired to an RC4Magic DMXio transmitter, and live DMX channel data must be streaming.

The first channel in the DMX universe that is at a non-zero level will be assigned as the DMX Start Channel. The Start Channel must be at the correct level for the pixel type being used:

Dec Level	% Level	String Type Selected
0 – 37	<15%	Channel Ignored
38 – 101	30%	WS2811/WS2812 *
102 – 152	50%	WS2801
153 – 203	70%	APA102 (default for DMXpix)
204 – 255	100%	SK6812RGBW (4-colors per pixel)

Additional pixel types can be selected using Remote Device Management (RDM).

Setting only this parameter, with all other DMX channels at zero, will change the DMX Start Channel and pixel type without changing other CPP parameters.

* WS2812 is the most common data protocol for pixel control. There are many compatible products. If you are using a 3-wire device with D but no C connection, it will most likely work using the WS2812 driver setting. The SK6812RGBW uses the same data protocol but allocates 4 control channels to each pixel, for 4 colors.

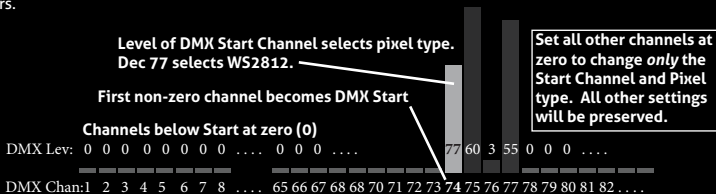

Select Pixel Color Order

Repeatedly pressing the same Set button will cycle through 6 color orders. Select the color-order of the pixel product being used, and the DMXpix will re-order the control channels for red/green/blue control from your console:

RGB  (red/green/blue, default)

GRB 

RBG 

BRG 

GBR 

BGR 

NOTE: When using RGBW 4-color pixel products, only the first 3 colors are rotated to change color order. The 4th channel in each pixel must be white.

Set Keyframe Length in Pixels



The channel immediately after the DMX Start Channel sets the Keyframe Length in pixels, limited to the range 1 - 170. A value of zero will be ignored, so the previously set Keyframe Length will remain unchanged. Values higher than 170 will set a length of 170 pixels.

The default Keyframe Length is 170 RGB pixels, using 510 DMX channels.

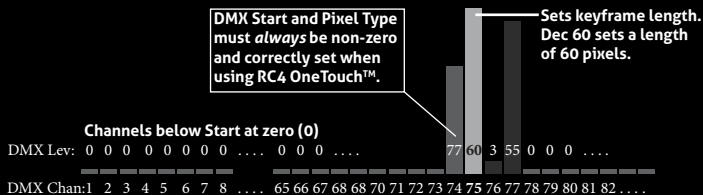

Set Group Size in Pixels



The second channel after the DMX Start Channel sets the Group Length in pixels. A value of zero will be ignored, so the previously set Group Length will remain unchanged.

For decimal values 1 - 250, that value directly becomes the Group Length. The remaining high levels result in the following Group Lengths:

DMX Chan Lev	Group Length Selected
251	300
252	350
253	400
254	450
255	500 (unison mode)

A Group Length of 500 with a Keyframe Length of 1 is Unison Mode, where all pixels in a string are controlled by just three DMX channels (DMX Start Channel for red, the next channel for green, the next for blue).

The default Group Length is 1.

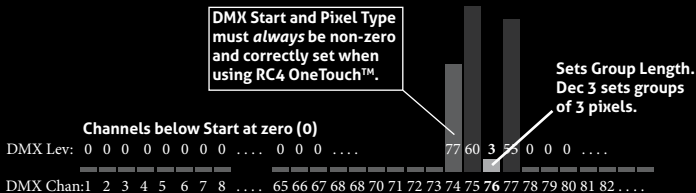

Set Pattern Replication Method

This parameter is configured to support 12 different methods of extending the Keyframe pattern over the length of all pixels controlled by a CPP driver. The first 4 methods are currently assigned. The remaining 8 methods are not yet designed, and selecting one will default to method 1 (Incremental).

A Replication Method is always active. When using a 170 pixel keyframe, replication will apply from the 171st pixel through to the 500th. Data for all 500 pixels is always there, regardless of how many real pixels are connected.

Ch Lev Replication Method Selected

0 – 15: No Function, channel ignored.

16 – 31: **Increment Channels (default):** Repeat Keyframe beginning to end:

32 – 47: **Decrement Channels:** Repeat Keyframe end to beginning, starting with a mirrored (reversed) keyframe:

48 – 63: **Inc/Dec Channels:** Alternating Increment and Decrement patterns:

64 – 79: **Dec/Inc Channels:** Alternating Decrement and Increment patterns starting with a mirrored (reversed) keyframe:

80 – 255: Reserved for additional Replication Methods in the future.

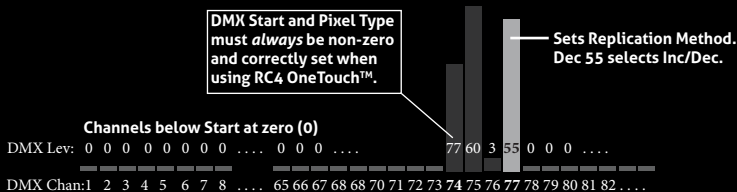

Performing a Factory Reset

If someone else has used your DMXpix, or you just want to get back to a known configuration, performing a factory reset is easy:

Power on the device. Wait until start-up is complete and the green COP indicator is blinking continuously.

Press and hold Func, briefly tap (press and release) the SetA button, then release Func. The first four indicators will blink to confirm that factory settings are restored.

NOTE: This process restores your RC4 Private System ID to ID0. It does not change the Unit Number if one has been assigned. Learn more about IDs on the next page. Learn more about Unit Numbers when using RC4 Commander configuration software.

PRO TIPS:

Bending a single paper clip into a U shape will enable you to easily reach and press both buttons together.

If you are not sure what mode or setting you may have selected, you can always get back to a known starting point by returning to factory default.



Advanced Features

The DMXpix is a multifaceted device for users of all experience levels. The features below can be explored further at <http://rc4.info/> or by asking us for help at support@rc4wireless.com:

- RC4 Commander software, available for Mac OSX and Windows, provides a rich user interface for configuring multiple RC4Magic devices remotely.
- The DMXpix can also be configured with an RDM controller, via a wired connection to the DMX/RDM data port. Wireless RDM is not supported.
- In addition to the pixel types referred to in this Quick Start Guide, the DMXpix can also control LPD8806 pixels, MY9231 pixels*, and Port B can control strings that read DMX data directly. New pixel types will be supported with firmware updates from time to time , all of which can be selected using DMX Remote Device Management (RDM).
- The DMXpix includes RC4 ColorMatch™, allowing you to visually match the color rendering of different pixel strings. This lets you use multiple string types, brands, and batches that do not inherently look the same, and correct their output for better color continuity.
- Using a small adaptor cable, the DMXpix can be used as a wireless data receiver to deliver DMX to other devices. It can also be used as a wired DMX pixel driver: the miniplug DMX port becomes an input when the device is not linked to a transmitter.

* MY9231 control requires a very small clock adaptor module between the DMXpix and the first pixel, available from RC4 Wireless.

Caring for Your DMXpix

- **Do not connect the DMXpix to AC power or any voltage higher than 35VDC.** Doing so will damage the device and is not covered under warranty.
- **Do not exceed the maximum total power handling through the DMXpix**, which is 6A. Connect larger pixel loads directly to the power source. *A common ground is always required between the DMXpix and the pixels.*
- Always use a fuse or circuit breaker at the power source, and a safe wire size for the fuse rating. For example, with a 10A fuse, use wire rated to carry 10A.
- The DMXpix should be kept away from excessive heat, cold, dust and moisture.
- Do not immerse in water or other fluids.

Failing to observe appropriate safety precautions can result in fire or other risk. RC4 Wireless cannot be held responsible or liable in such cases.

Get in Touch

North Carolina, USA: 1-866-258-4577 or 1-919-229-9950

London, UK: +44 (0)20 3289 8765

Email: support@rc4wireless.com

Website: www.rc4wireless.com

Knowledge Base: <http://rc4.info>

We're here to help!

James David Smith

President and Chief Product Designer

RC4 Wireless