

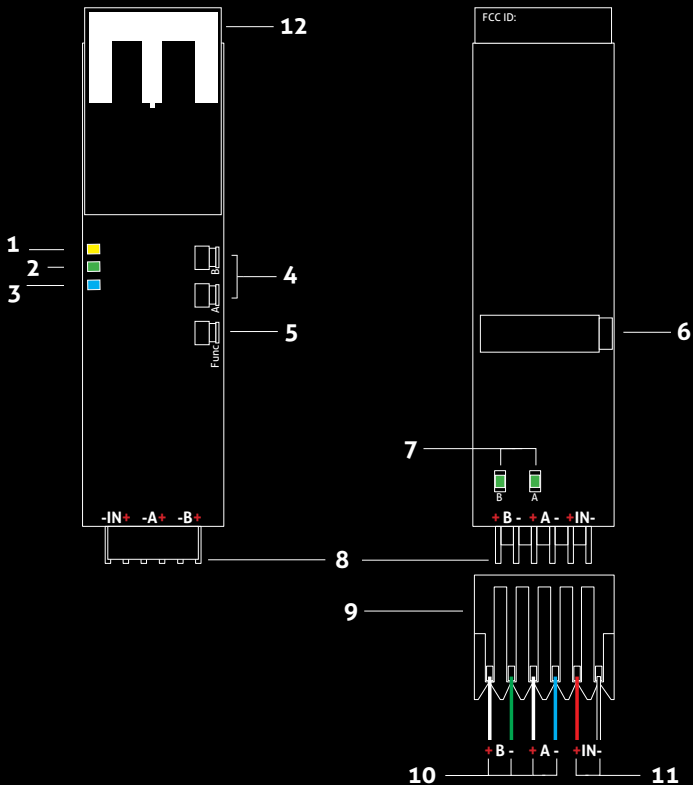

RC4Magic Series 3
DMX2micro
Miniature Two-Channel Wireless Dimmer
Quick Start Guide

Rev. 1.0A



RC4 DMX2micro

1. DMX Data Indicator
2. Function and COP ² Indicator
3. RF Connect Indicator
4. SetA, SetB Buttons
5. Function Button (Func)
6. DMX In/Out Data Port
7. DimA, DimB Indicators
8. Male Connector Pins for Power In and Dimmer Outputs
9. Disconnectable Female IDC Connector ¹ for Power In and Dimmer Outputs
10. Load Connection Wires (DimA +/- and DimB +/-)
11. Power Connection Wires (DCin +/-)
12. RF Antenna

1. Connector is Amp MTA-100-Series, 0.1" pin spacing. Shell color indicates wire gauge. Red shell is for 22 AWG wire, Amp connector P/N 3-641190-6. Numerous alternatives are available, each with different P/Ns. Use the correct shell for the wire you are using. Amp also supplies crimping tools for these connectors. One 22 AWG connector assembly is included with each DMX2micro. Additional cable assemblies are available from RC4 Wireless.

2. COP means "Computer Operating Properly." This indicator always shows a blink pattern, proving that internal firmware is running. Different patterns indicate various modes and advanced settings.

DMX2micro Quick Start Guide

Most RC4Magic DMX2micro users will find all the information they need right here. Your DMX2micro also has a wide variety of advanced features. You can find out more about them in the RC4 Knowledge Base at <http://rc4.info>.

RC4Magic devices arrive ready to use. You probably do not need to change any settings. Just add DMX!

Registering Your Product

Registration ensures you'll be notified of new firmware updates, and warranty claims can be resolved more quickly. Please complete your registration at: www.rc4wireless.com/support/register/

Get in Touch

North Carolina, USA: 1-866-258-4577 or 1-919-229-9950

London, UK: +44 (0)20 3289 8765

Email: support@theatrewireless.com

Website: www.rc4wireless.com

Knowledge Base: <http://rc4.info>

We're here to help!



James David Smith

President and Chief Product Designer
RC4 Wireless

DMX2micro System Components

To use your DMX2micro wireless dimmer you will need:

- A DMX lighting console.
- An RC4Magic Series 2 or Series 3 DMXio Transceiver.*
- A battery or DC power supply for the dimmer and loads you will be operating with it.

* Or you can connect a DMX data source directly and use your DMX2micro as a low-voltage wired dimmer. To do this, you need an adaptor cable from male XLR5 to RC4 miniplug.

RC4Magic Private IDentities™

RC4 Private IDentities™, unique to RC4Magic wireless DMX systems, keep your data private and safe on a Virtual Private Network (VPN) separate from other systems, with robust resistance to signal loss and slow down.

Each Private ID transports a separate DMX universe. Multiple systems can operate at the same time for multiple wireless universes in the same space.

Each new RC4Magic customer and project is assigned a unique set of Private ID codes — nobody else has your IDs. They are marked on each device. Please note your private IDs below. When you add devices to your system, you must verify your IDs at time of purchase:

ID0 _____ **ID1** _____ **ID2** _____

ID3, code 999, is the RC4 Public ID. It is identical in all RC4Magic Series 2 and Series 3 devices ever made. Always use one of your private IDs when possible.

Your Private ID0, the factory default, is ideal for most users.

Performing a Factory Reset

If someone else has used your DMX2micro, or you just want to get back to a known configuration, performing a factory reset is easy:

Power on the device. Wait until start-up is complete and the green COP indicator is blinking continuously.

Press and hold the Function (Func) button, briefly tap (press and release) the SetA button, then release Func. The first four indicators will blink to confirm that factory settings are restored.

NOTE: This process restores your RC4 Private IDentity™ to ID0. It does not change the Unit Number if one has been assigned. Learn more about IDs on the next page. Learn more about Unit Numbers when using RC4 Commander configuration software.

PRO TIPS:

Bending a single paper clip into a U shape will enable you to easily reach and press both buttons together.

If you are not sure what mode or setting you may have selected, you can always get back to a known starting point with a factory reset.

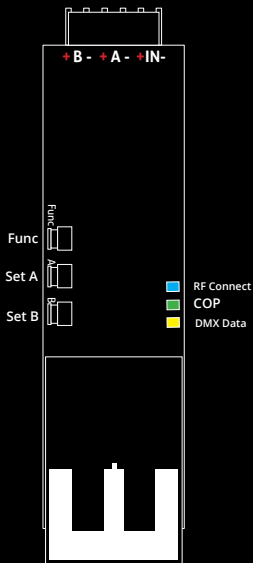

Confirming and Setting an RC4 System ID

All RC4Magic devices being used together must be set to the same RC4 System ID.





On power-up, the currently selected System ID is indicated with a blink pattern on the DMX Data and COP indicators. The four different patterns are noted below.

The factory default ID0 is indicated with a few rapid blinks of the yellow DMX Data LED on power-up. A factory reset will restore this ID setting.

An ID can be selected by holding one button or a pair of buttons on power-up. The blink pattern for the newly selected ID will appear on the indicators. You can also confirm the currently selected ID at any time by cycling power and watching the blink pattern that appears at start-up.

To select ID0, hold the SetA button, apply power, and release the button when the blink pattern appears. To select ID1, hold the SetB button and apply power. To select ID3 (the public, not private, ID), hold both SetA and SetB and apply power. *NOTE: On 3-button devices, ID2 can only be selected with RC4 Commander software.*

All RC4Magic Series 3 devices indicate IDs in the same way, making it easy to quickly confirm that all devices in your system are set correctly to work together.

-  **ID0 (default)**, yellow blink. Hold SetA on power-up to select ID0.
-  **ID1**, green blink. Hold SetB on power-up to select ID1.
-  **ID2**, yellow and green blink together. *Cannot be selected manually.*
-  **ID3 (public)**, yellow and green alternate. Hold SetA & SetB on power-up to select ID3. *Note: ID3 is public and is less secure than Private IDs.*

Connecting with an RC4Magic DMXio Transceiver

All RC4Magic devices configured on the same RC4 Private Identity™ will automatically connect and form a VPN (Virtual Private Network). Confirm that each device in your system is labeled with the same RC4 Private Identity™ codes, and that each device indicates the same System ID selection on power up (see page 7). The default is ID0, which is fine for most users.

When first powered up, or after a transmitter has gone off and then come back on line, **receivers can take up to 10 seconds to join the VPN**. This is normal, and it is usually much less than 10 seconds.

A DMXio transceiver in Auto Mode (the default setting) will automatically detect wired DMX data from your console and establish itself as the master transmitter.

RC4Magic devices from a different system will not work with your RC4 Private IDs. This is the key to RC4Magic data security and superior performance for all users.

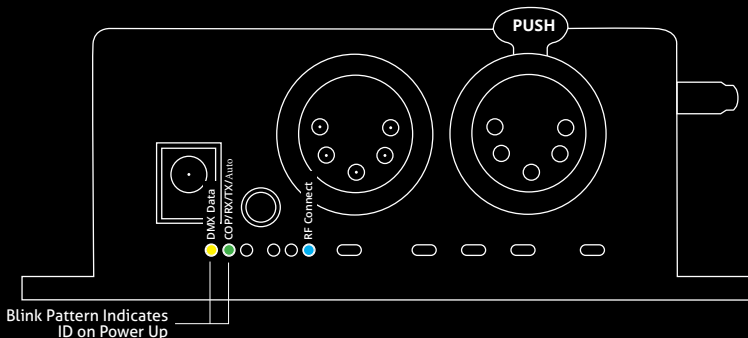



RC4Magic Indicator LEDs After Power-Up

The **COP** indicator blinks with different patterns to indicate various device modes. The **DMX Data** LED indicates that DMX data is present, either from a connected DMX controller, or from the VPN wireless link. If the yellow indicator is not active, no DMX data is present.

DMX Data:  Yellow blinks with data packets and may appear irregular:

On DMXio transceivers operating in transmitter mode (see page 8), the RF Connect LED blinks slowly to indicate that a wireless VPN has been formed and the DMXio is the master transmitter:

DMXio, Transmit Mode COP Pattern:  Green long blinks indicate transmitter mode:
RF Connect: 

RC4Magic Series 3 (2.4GHz)

Your DMX2micro is part of an **RC4Magic Series 3 system operating in the 2.4GHz band**. The RF Connect indicator remains on (not blinking) while the DMX2micro is searching for your VPN. It blinks quickly and continuously while your DMX2micro is connected to your wireless VPN.

DMX2micro RF Connect, Searching: 
Connected: 

Assign the DMX Starting Address

Begin with all channels in the DMX universe off, at zero (0).

Bring up the DMX channel that will be the DMX2micro starting address. Set it to 30% (Decimal 77) to select a curve that is optimized for smooth LED dimming.

Tap the SetA button to capture settings. They are now saved until you change them. Proceed to setting other dimmers, or return to using your DMX console as you normally do.

*A channel level of 30% selects one of several different curves.
Other curves are explained on page 13.*

Subsequent Channel Assignment

When you set DimA, then DimB is automatically set to the next consecutive channel. For example, if you have set DMX channel 74 for DimA, DimB is now assigned to channel 75.

Non-Sequential Channel Assignment

Dimmers don't have to be sequential.

If you want DimB to be set to DMX channel 11, bring up 11 @ 30% (for the LED curve) at the console and press the SetB button.

Remember: SetA assigns both dimmers sequentially. SetB assigns only DimB. *Always use SetA first.*

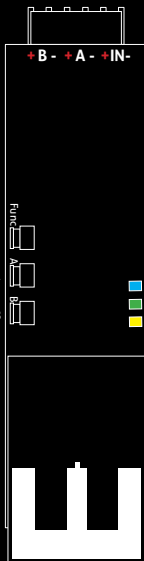

Test the Wireless Link with Default Address Settings

When you receive your new DMX2micro, or after restoring default settings, it will be set to DMX channel 1 for dimmer A, 2 for dimmer B, and so on.

Before changing any settings, play with DMX levels for these channels to see your wireless dimmers work. DimA, DimB, DimC, and DimD LED indicators are connected to the outputs to show you exactly what the dimmers are doing.

Setting DMX Addresses and Curves with RC4 OneTouch™

RC4 OneTouch™ uses DMX channel levels to set parameters. To use it, the DMX2micro must be paired with an RC4Magic DMXio transmitter, and **live DMX channel data must be streaming**.

Begin with all channels in the DMX universe off, at zero (0). This includes channels used for house-lights, and moving-light parameters like pan and tilt.

Bring up one DMX channel. This will become the DMX2micro starting address. The level of the channel selects a dimmer curve.

Tap a dimmer Set button to capture settings. They are now saved until you change them. Then you can return to using your DMX console normally.

RC4 OneTouch™

The first channel up sets DMX Start.
In this example, it is channel 74.

Level of DMX Start sets
dimmer curve. Decimal
77 is 30%, selecting the
ISL Slow curve for LEDs.

Channels below Start MUST be at zero (0)

DMX Lev: 0 0 0 0 0 0 0 0 0 0 0

DMX Chan: 1 2 3 4 5 6 7 8 65 66 67 68 68 70 71 72 73 74 75 76 77 78 79 80 81 82

Connecting Your Lamps, LEDs, Motors and More*

To really use your DMX2micro, you must connect a lamp, LED, motor, or other load to each dimmer. When you're connecting anything to your DMX2micro, be sure that the DMX2micro is powered down. Connect everything first, then turn on power.

Connections should be made to an MTA-100 connector. Attach the connector to the DMX2micro after wiring is completed and checked, then apply power.

* The DMX2micro can control a variety of devices including solenoids, relays, servo motors, and much more.

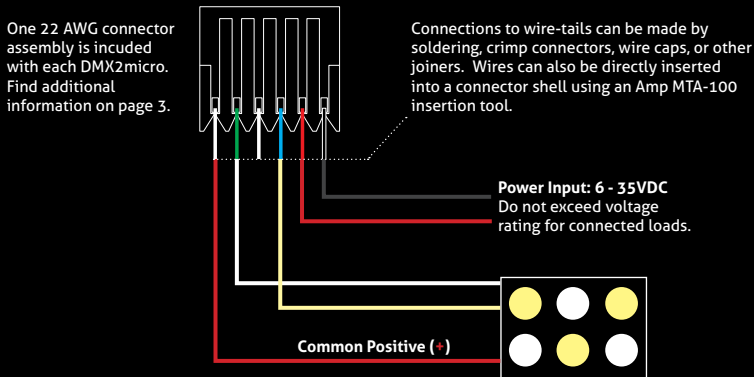

Dimming and Controlling Multicolor LEDs

The illustration on page 12 shows a 2-color LED device*. There are 3 wires: a grey wire for the common positive (+), and two colored wires, green and blue, for the two unique negative leads. The color of the common positive may vary, it is only grey for illustration.

The common positive wire should be connected to the (+) under DimA. All of the (+) terminals are connected together inside the DMX2micro. Using the DimA (+) connection is recommended because it is closest to the power input (+) connection, reducing heat and resistance along the positive leg of the circuit.

Dimming happens on the negative (-) terminals.

One negative load wire should be connected to the negative (-) terminal under DimA.

The other negative load wire should be connected to the negative (-) terminal under DimB.

When using individual devices, like MR16 halogen lamps, connect the two leads of the device to the two dimmer output terminals (+ and -).

* When using 2-color tungsten/daylight (warm white/cool white) LED strips or panels, you can use Crossfade Mode for precise control of color temperature and intensity. More information about selecting modes can be found at <http://rc4.info>.

Choosing Other Dimmer Curves or Profiles

The DMX2micro default is the ISL dimmer curve, which is best for LEDs. This is also the curve that is selected with RC4 OneTouch™ when the DMX level is at 30%.

There are many dimmer curves for different kinds of lamps, motors, and more. Selecting advanced curves can be done with RC4 Commander software, Remote Device Management (RDM), or RC4 Enhanced OneTouch™. More information about all these things can be found online at <http://rc4.info/>.

The most common curves are selected using these DMX channel levels and RC4 OneTouch™ with the Set buttons as outlined on page 10:

<i>Non-Dim</i>	100% (80% or higher) Use for relays, solenoids, air valves, etc.
<i>Linear</i>	70% (60 - 79%) For incandescent, halogen, tungsten lamps.
<i>ISL Fast</i>	50% (40 - 59%) For LEDs when fast blinks and flashes are required. RC4 Digital Persistence™ is disabled.
<i>ISL Slow</i>	30% (20 - 39%) Best for typical LED applications, with RC4 Digital Persistence™. For super smooth 19-bit dimming. (default setting)

Advanced Features

The DMX2micro is a multifaceted device for users of all experience levels. The features below can be explored further at <http://rc4.info/> or by asking us for help at support@rc4wireless.com:

- RC4 Commander software, available for Mac OSX and Windows, provides a rich user interface for configuring multiple RC4Magic devices remotely.
- The DMX2micro can also be configured with an RDM controller, via a wired connection to the DMX/RDM data port. Wireless RDM is not supported.
- Using a small adaptor cable, the DMX2micro can be used as a wireless data receiver to deliver DMX to other devices. It can also be used as a wired DMX dimmer: the miniplug DMX port becomes an input when the device is not linked to a transmitter.
- When using the DMX2micro for cinema (motion picture capture), PWM frequencies can be adjusted for the smoothest dimming without visible banding or other artifacts.
- The DMX2micro has a wide variety of dimmer curves that can ring telephones, position servo motors, and more.
- Using the RC4 Flkr Effects Engine™, you can create many unique effects including candle flicker, analog tv screen noise, welding spark, and much more.
- When using 2-color tungsten/daylight (warm white/cool white) LED strips or panels, you can use Crossfade Mode for precise control of color temperature and intensity.

Caring for Your DMX2micro

- The DMX2micro is a circuit-board assembly without a protective case. **This makes it more sensitive to damage by static discharge than enclosed devices.** When wiring and installing this device in an application, take appropriate precautions for handling exposed electronics, including a grounded work mat and static discharge strap. *Failure caused by static damage is not covered under warranty.*
- **The DMX2micro should not be used with AC power or with any voltage higher than 35VDC.** Doing so will severely damage the device and is extremely dangerous for the operator.
- Do not exceed the maximum total power handling of the DMX2micro, which is 6A. That is 72W at 12V, 144W at 24V, shared across the two dimmer channels.
- Always use a fuse or circuit breaker at the source of power and always use an appropriate wire size for the fuse rating. For example, if using a 3A fuse, use wire that can safely carry 3A.
- The DMX2micro should be kept away from excessive heat, cold, dust and moisture.
- Do not immerse in water or other fluids.
- Dimmers generate heat when operating. Allow space for air to move around the unit for cooling, especially when using high-current loads.

The DMX2micro is a high-power, high-current device. Failing to observe appropriate safety precautions can result in fire or other risk. RC4 Wireless cannot be held responsible or liable in such cases. Operate the DMX2micro at your own risk.